

World Sustainable Built Environment Conference, 5-7, June, 2017, Hong Kong

Energy Efficient Optimal Controls and Smart Energy Management of Buildings and Their Energy Benefits in Real Applications

Shengwei Wang

Chair Professor of Building Services Engineering

Building Energy and Automation Research Laboratory

Department of Building Services Engineering/Research Institute for Sustainable Urban Development, The Hong Kong Polytechnic University

beswwang@polyu.edu.hk

Outline

- **HVAC&R System Optimal Control Methods**
 - General considerations and methods
- **Case 1: Example of complex thermal comfort HVAC systems**
 - The tallest building in Hong Kong
- **Case 2: Example of special HVAC systems**
 - A clean room factory in Hong Kong
- **Case 3: Saving potential of demand limiting**
 - Analysis on buildings in the campus
- **Summary**

HVAC&R System Optimal Control Methods

--- General considerations and methods ---

HVAC&R System Optimal and Energy-Efficient Control

- Concerning poor quality (accuracy and uncertainty) of online measurements
- Robustness and sensitivity of control strategies (to measurement error/uncertainty, change of working conditions)
- Effective and robustness online optimization techniques
- Control of complex HVAC&R

HVAC&R System Optimal Control Methods

- Model-based Methods
- Performance map-based methods
- Rule-based methods
- Hybrid methods

Implemented in many real HVAC&R systems, including:
commercial buildings, hospitals, industrial/biomedical buildings and MTR underground stations, etc.

Locations for Optimal Control Logic Implementation

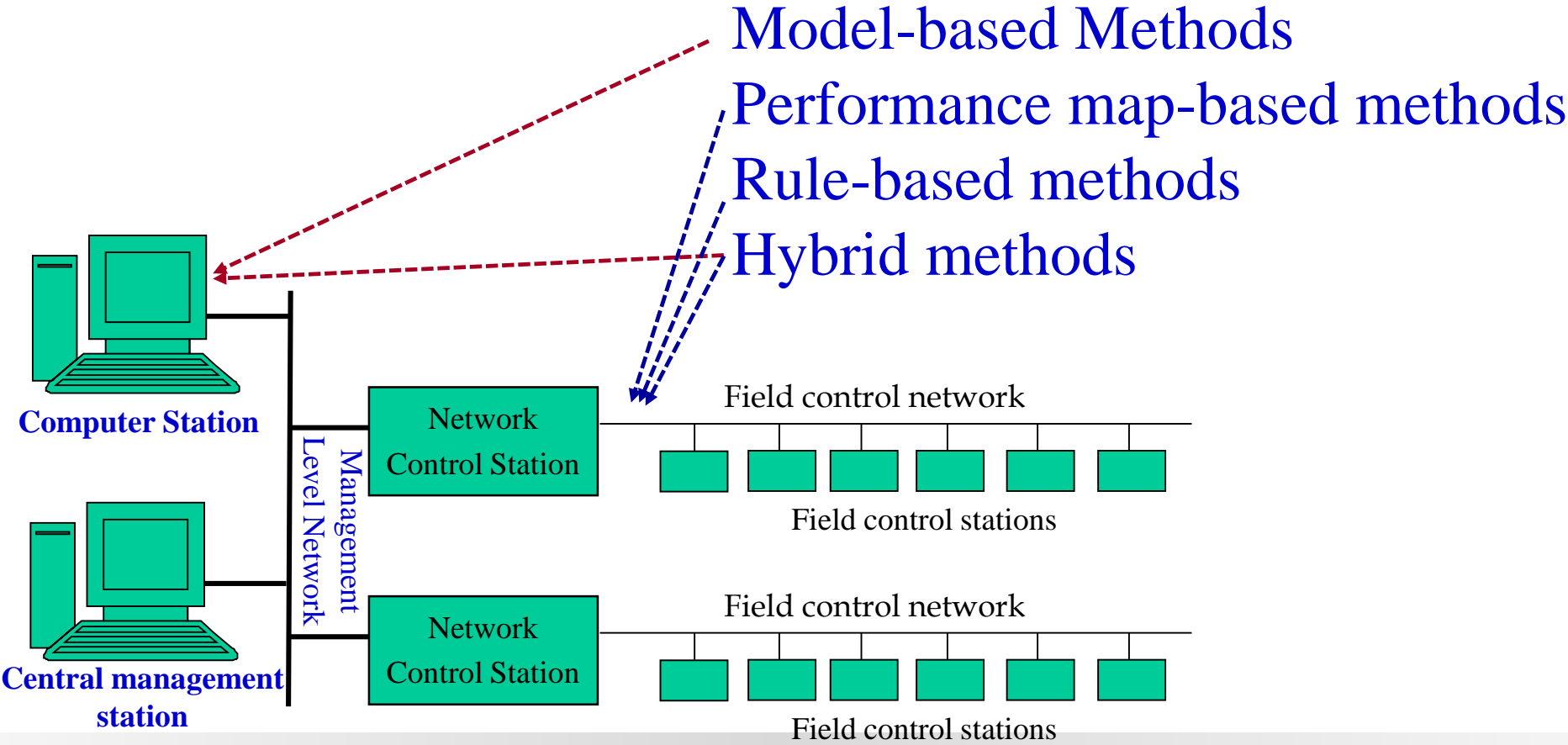

Examples of Optimal Control Strategy

--- Applications and Retrofitting ---

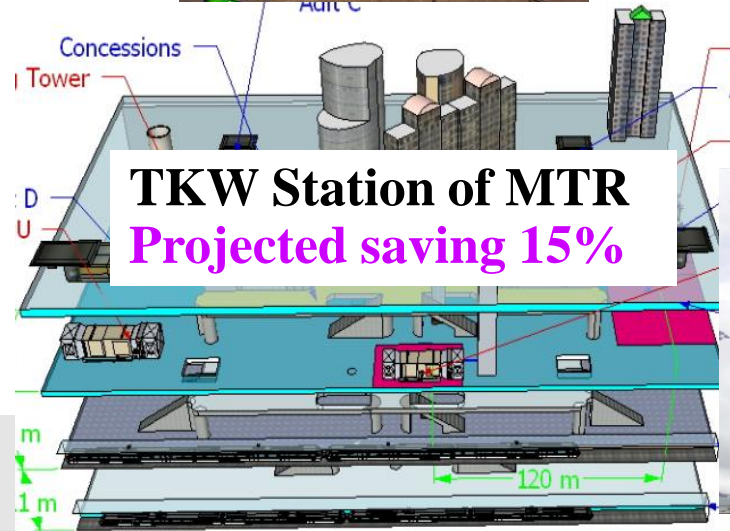

Case 1: Example of complex thermal comfort HVAC systems



Annual Energy Consumption (million kWh)

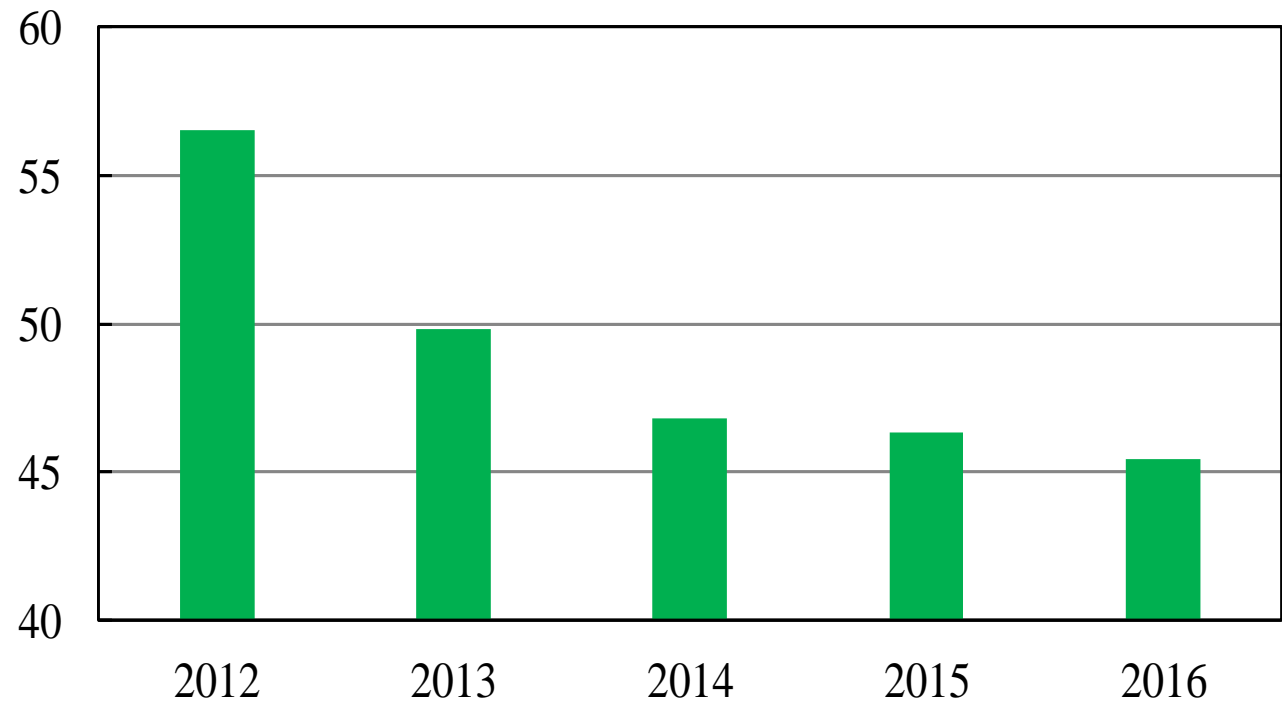

The actual annual saving in total consumption is over 10 million kWh

Optimized fresh air control

- **Demand Controlled Ventilation:** Reduce fresh air load without sacrificing Indoor Air Quality
- **Free cooling:** Provide free cooling during transient seasons

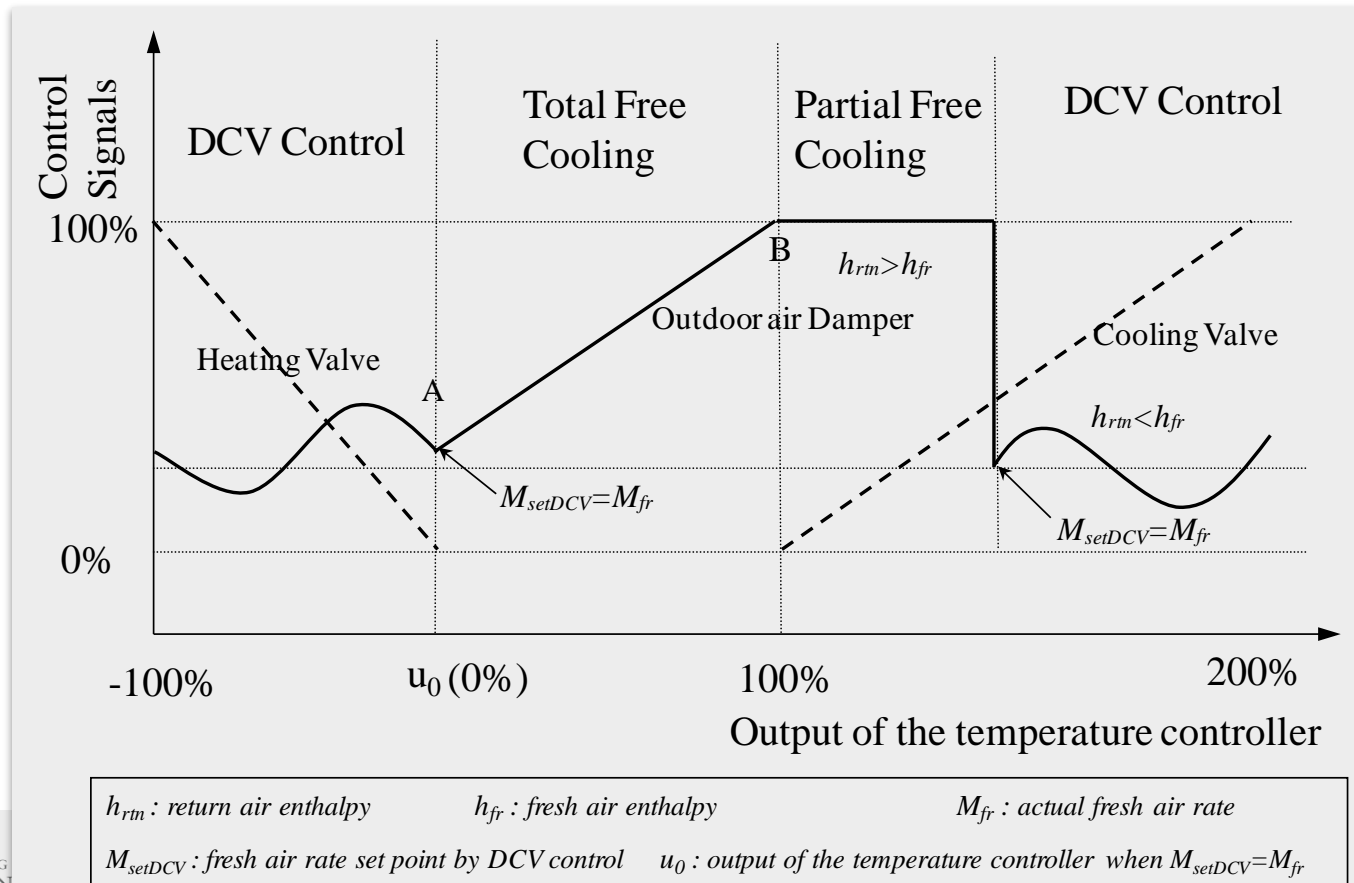

Optimized control of AHU supply air static pressure

Original Control:

Tend to fail when faults in VAV boxes, or too low room temperature set-points

Modified Control:

Tolerant to faults and improper user settings

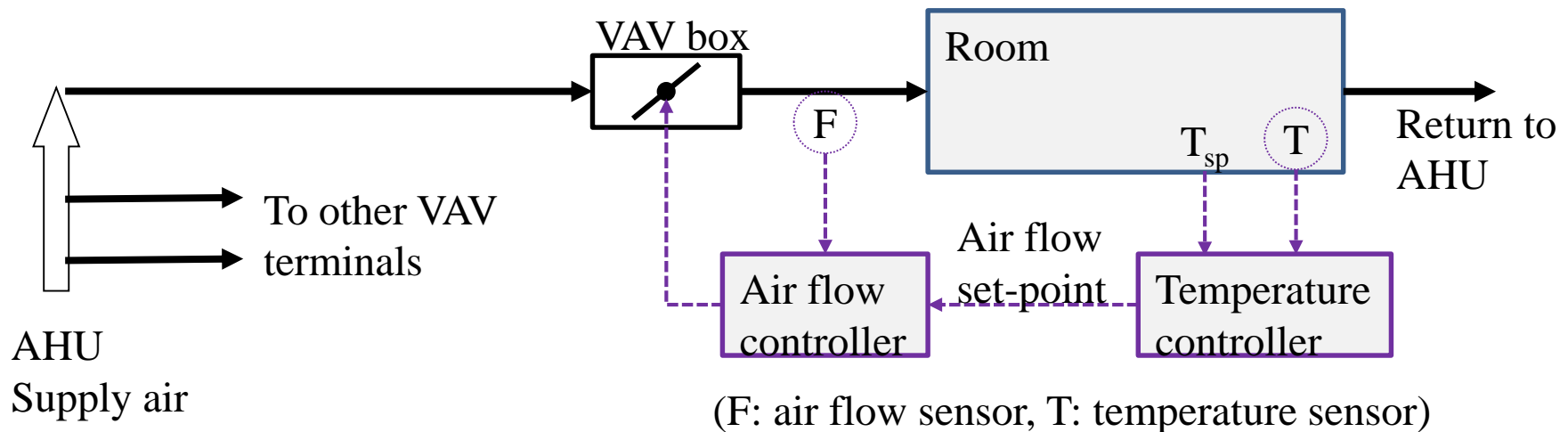

Allow two VAV dampers opening higher than 95%

Control the total air flow ratio within a certain range.

$$r_{sa} = \frac{v_{sa,total}}{v_{sa,sp,total}} \times 100\%$$

Optimized control of AHU supply air static pressure

Original Control method:
Too high set-points

Modified Control method:
Adaptive to actual conditions

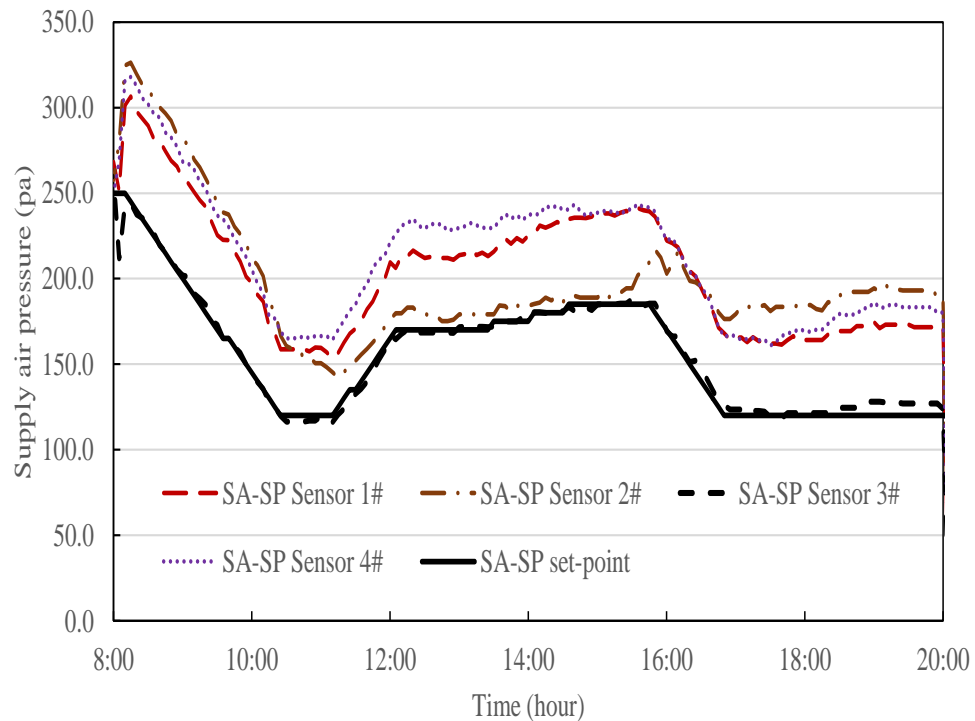
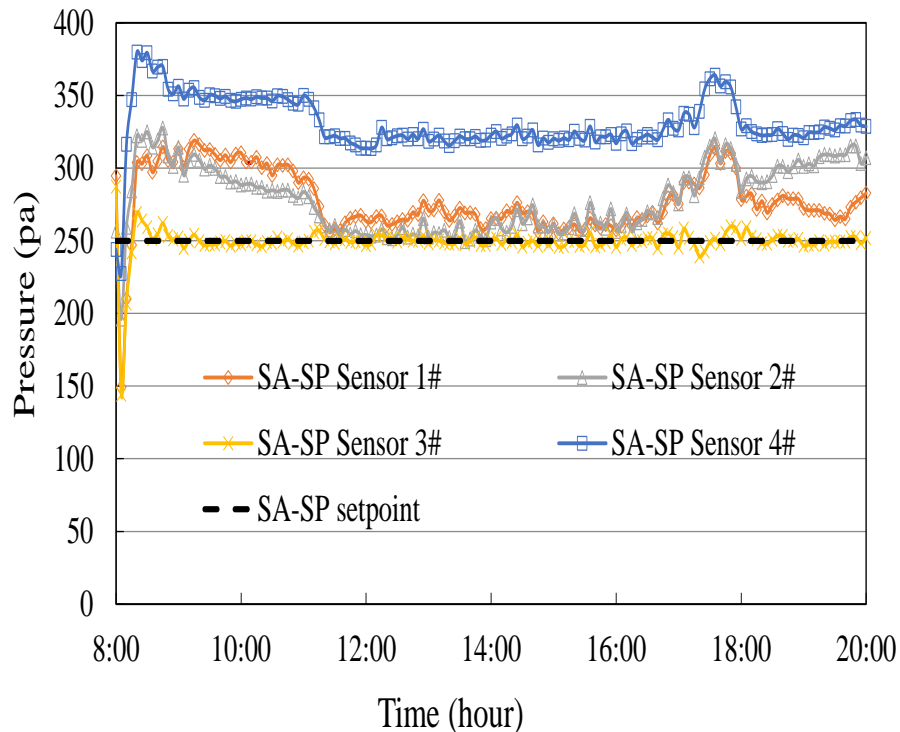

Optimal Control of Variable Speed Pumps

➤ *Speed control of pumps distributing water to heat exchangers*

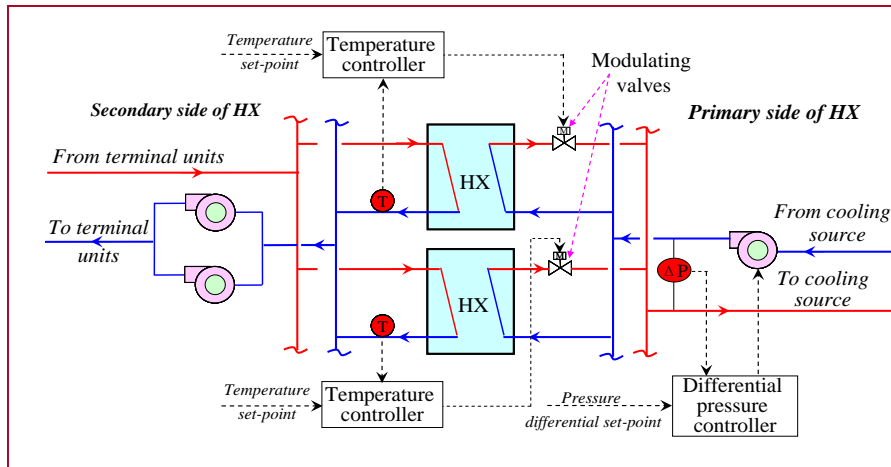

- *Original implemented strategy – differential pressure control and by resorting to the modulating valve*

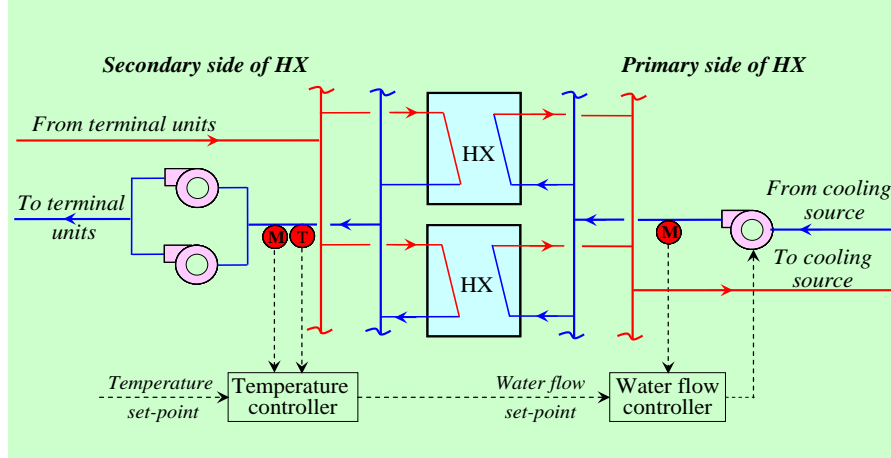

- *Revised strategy – cascade controller without using any modulating valve*

Robust building cooling load measurement technique

Based on Data Fusion

Cooling load measurement

➤ Direct measurement of building cooling load

$$Q_{dm} = c_{pw} \rho_w M_w (T_{w,rtn} - T_{w,sup})$$

c_{pw} is the water specific thermal capacity; ρ_w is the water density; M_w is water flow rate; $T_{w,rtn}$, $T_{w,sup}$ are chilled water return/supply temp.

➤ Indirect measurement of building cooling load

$$Q_{im} = f(P_{com}, T_{cd}, T_{ev})$$

P_{com} is chiller power consumption; T_{cd} , T_{ev} are chiller condensing/evaporating temperatures

Robust building cooling load measurement technique

Based on Data Fusion

- Data fusion to merge “Direct measurement” and “Indirect measurement” improving the accuracy and reliability of building cooling load measurement

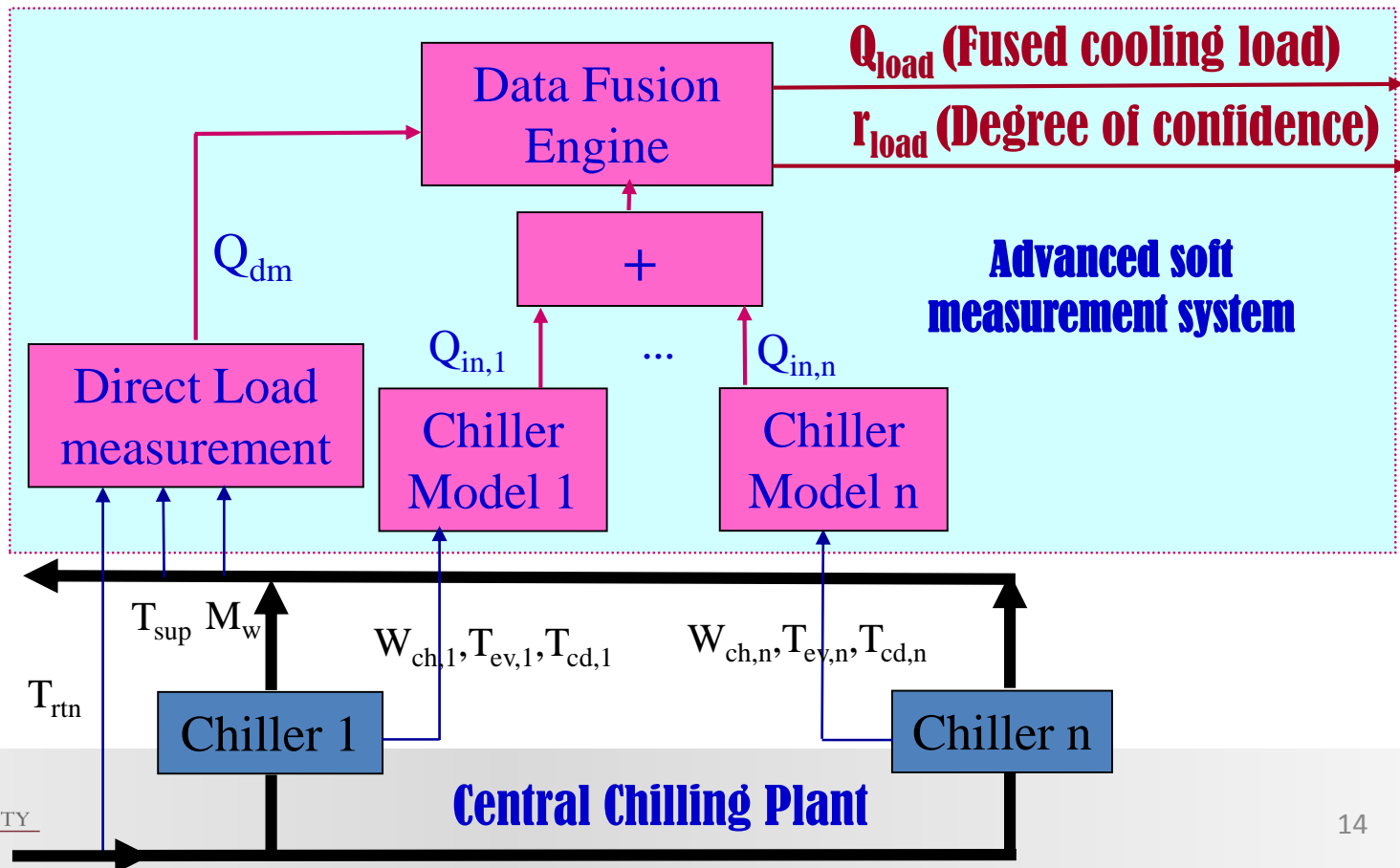

Robust Chiller Sequencing Control Based on Enhanced Cooling Load Measurement Technique

High degree of confidence => Accurate and relatively aggressive control

Medium degree of confidence => Less aggressive and safer control

Low degree of confidence => Safe control and warning for maintenance check

Alternative robust chiller sequencing control

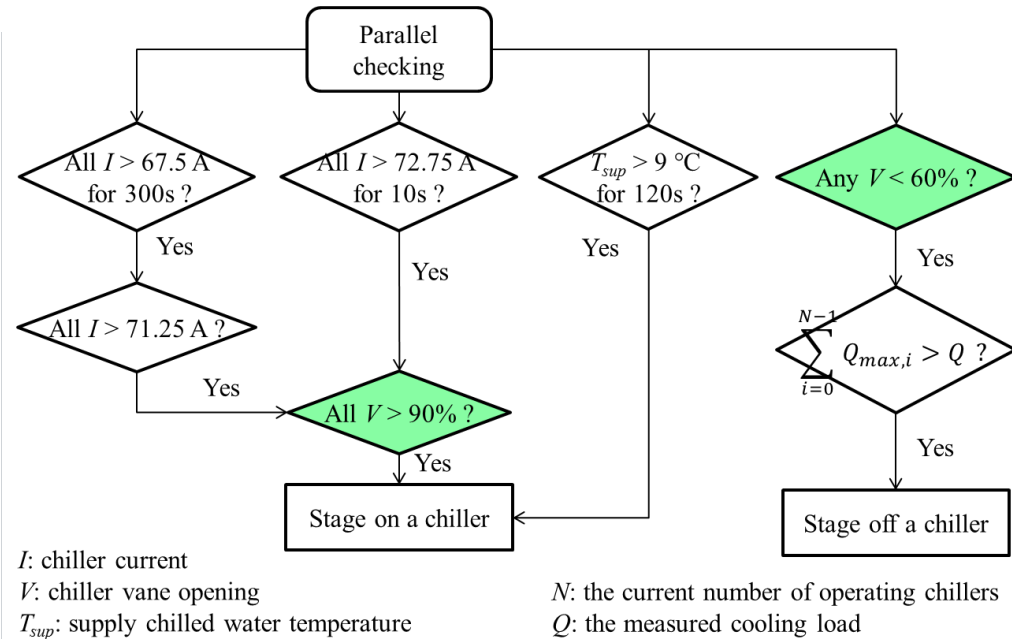
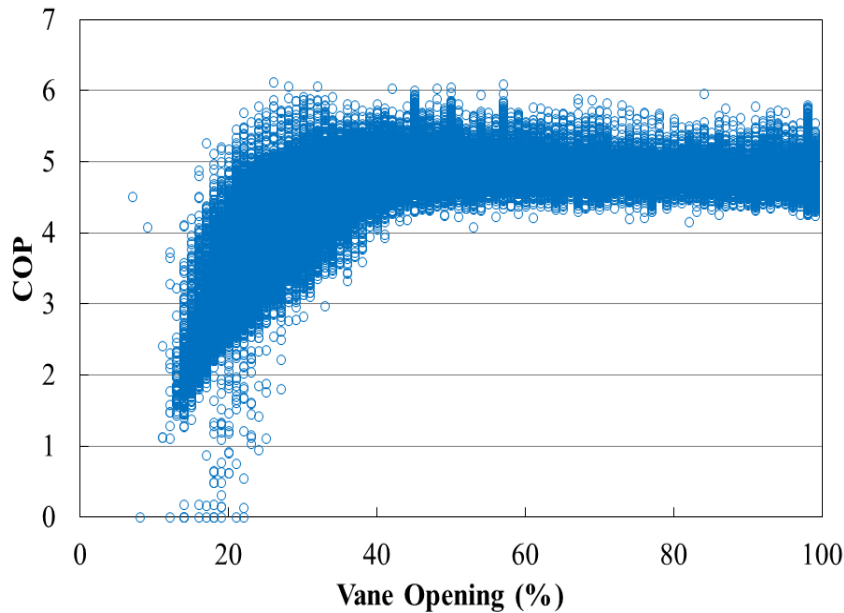

Inlet guide vane opening is a robust indicator of chiller efficiency.

This method is suitable for BMS without data fusion engine.

Optimized cooling tower control

The overall structure of the optimal control strategy

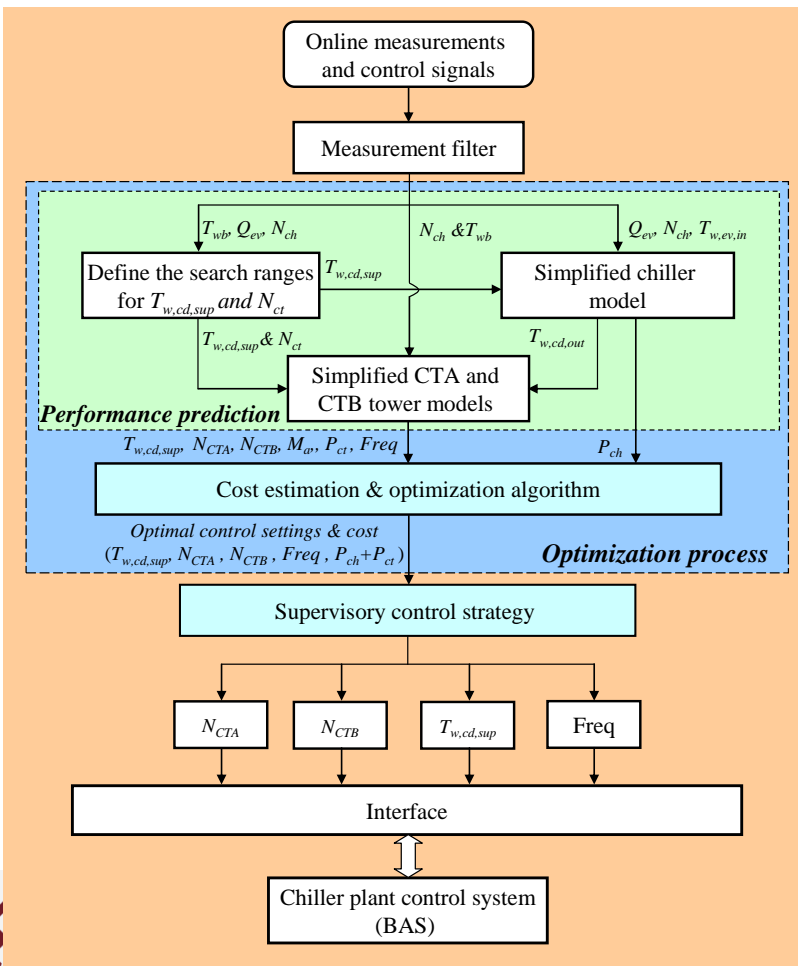

Optimization searches the best number and speed of cooling towers to minimize the total energy consumption of chillers and towers.

Optimization intends to use more towers at lower speed in practice.

Objective function

$$J = \min_{T_{w,cd,sup}} W_{tot} = \min_{T_{w,cd,sup}} \left(\sum_{k=1}^{N_{ch}} W_{ch,k} + \sum_{i=1}^{N_{CTA}} W_{CTA,i} + \sum_{j=1}^{N_{CTB}} W_{CTB,i} \right)$$

Case 2: Example of special HVAC systems

--- A cleanroom building in Hong Kong---



Example of Humidity and Temperature Control Retrofitting for cleanrooms

Original control strategy:

Uncoordinated heating/cooling (temperature and humidity) process controls - high counteraction between cooling and heating

Retrofitted control strategy: Well-coordinated heating/cooling (temperature and humidity) process controls - Unnecessary heating/cooling counteraction is avoided

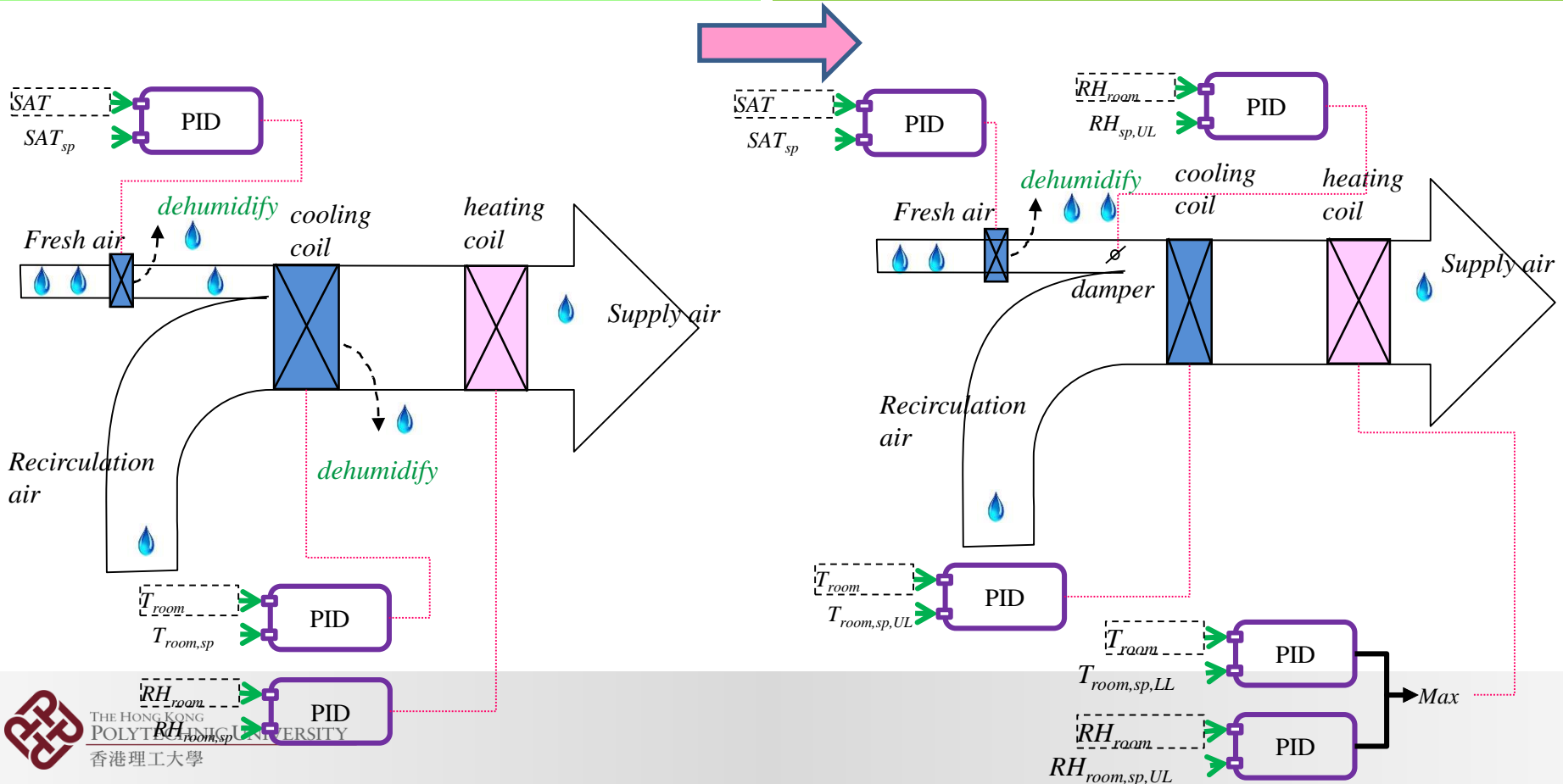

Summary of Annual Energy Cost Saving



Annual electricity and town gas savings are *982,000 kWh* and *14,562,000 MJ*. Total annual cost saving is about *4,185,000 HKD (42%)*.

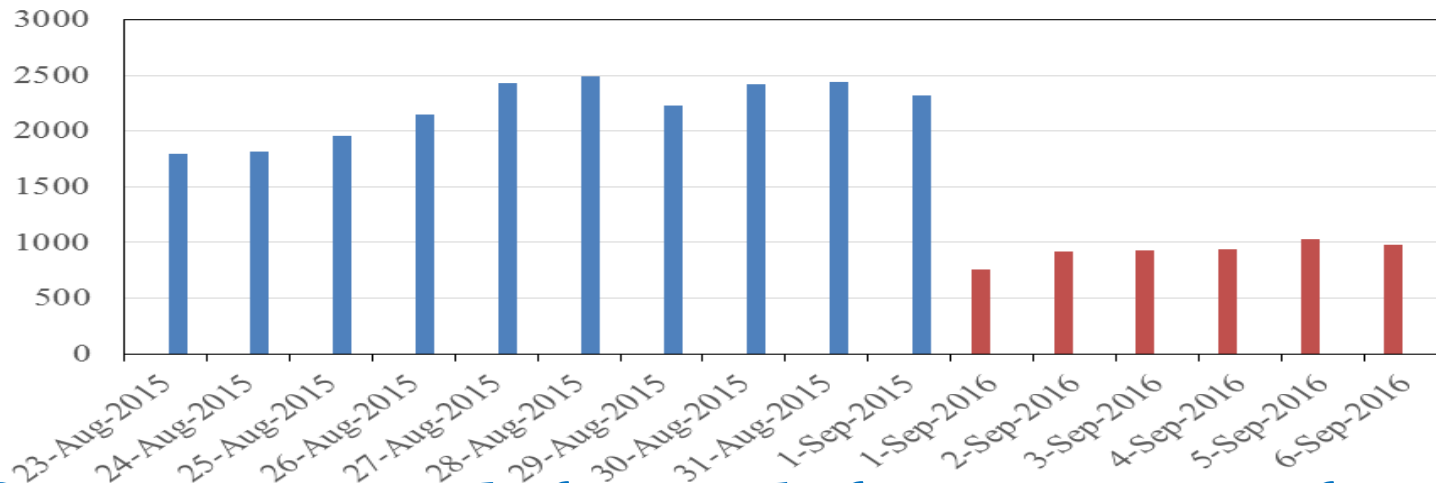

Gas consumption before and after control retrofitting

*Direct measured gas consumption before and after retrofitting
(in similar weather conditions)*

Case 3: Saving potential of demand limiting

--- Analysis on buildings in the campus ---

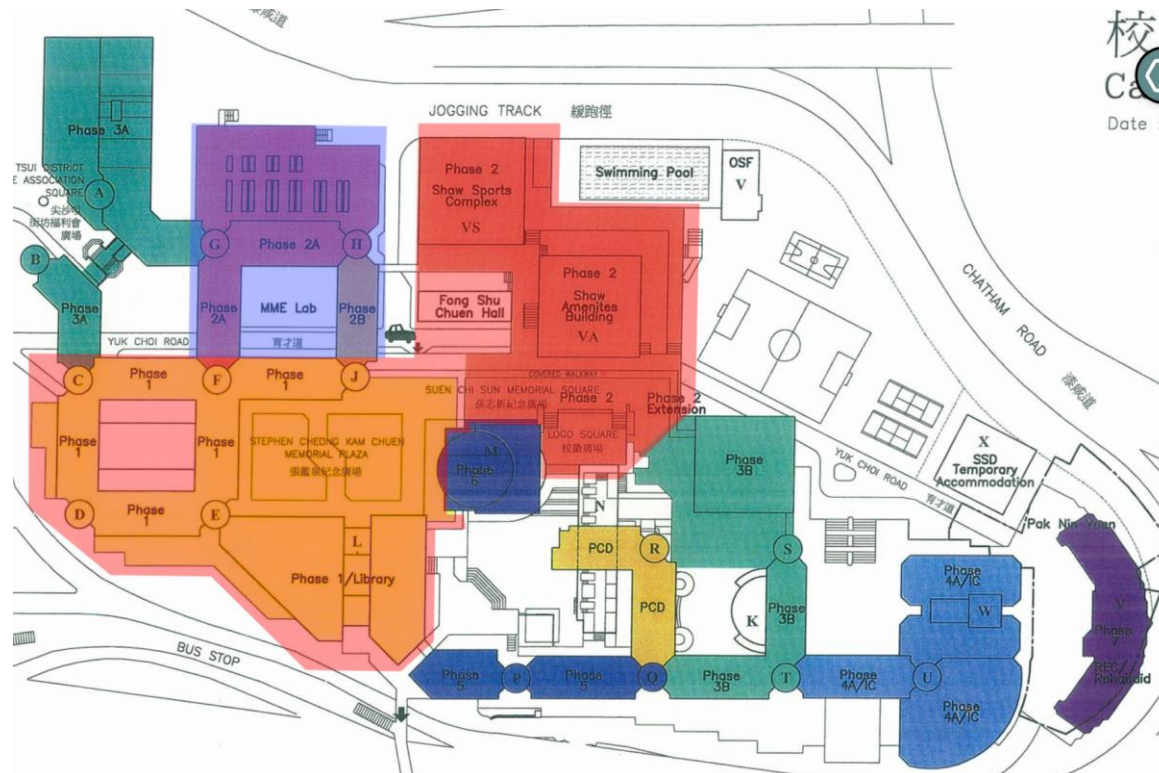

Current Incentives/Penalties - Proportion of electricity charges of an account in PolyU campus

■ DEMAND ■ ENERGY ■ FUEL

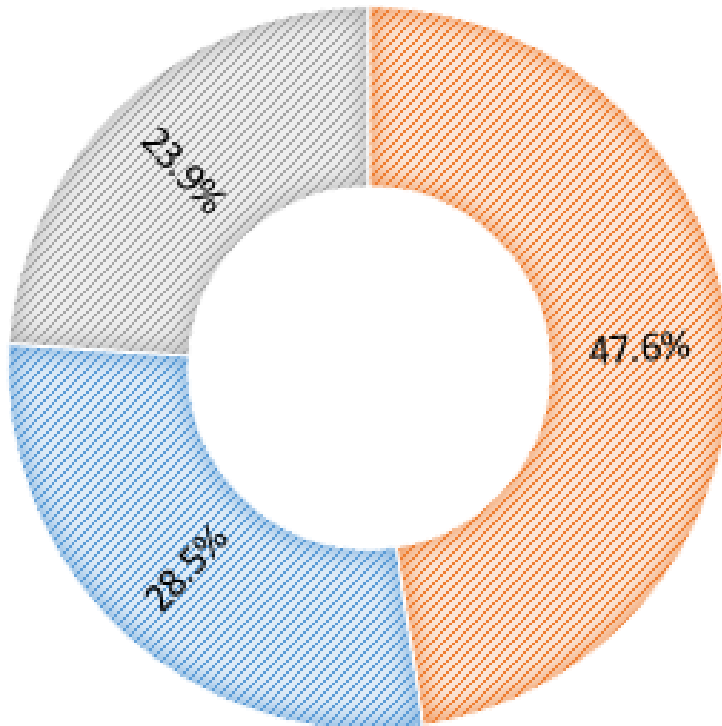

- **28.5 % based on demand (kVA)**
- **71.5% based on unit of consumption (kWh)**

Examples of actual electricity charges - Phase 7 in PolyU campus (Jan/2009)

Load duration, Jan 2009

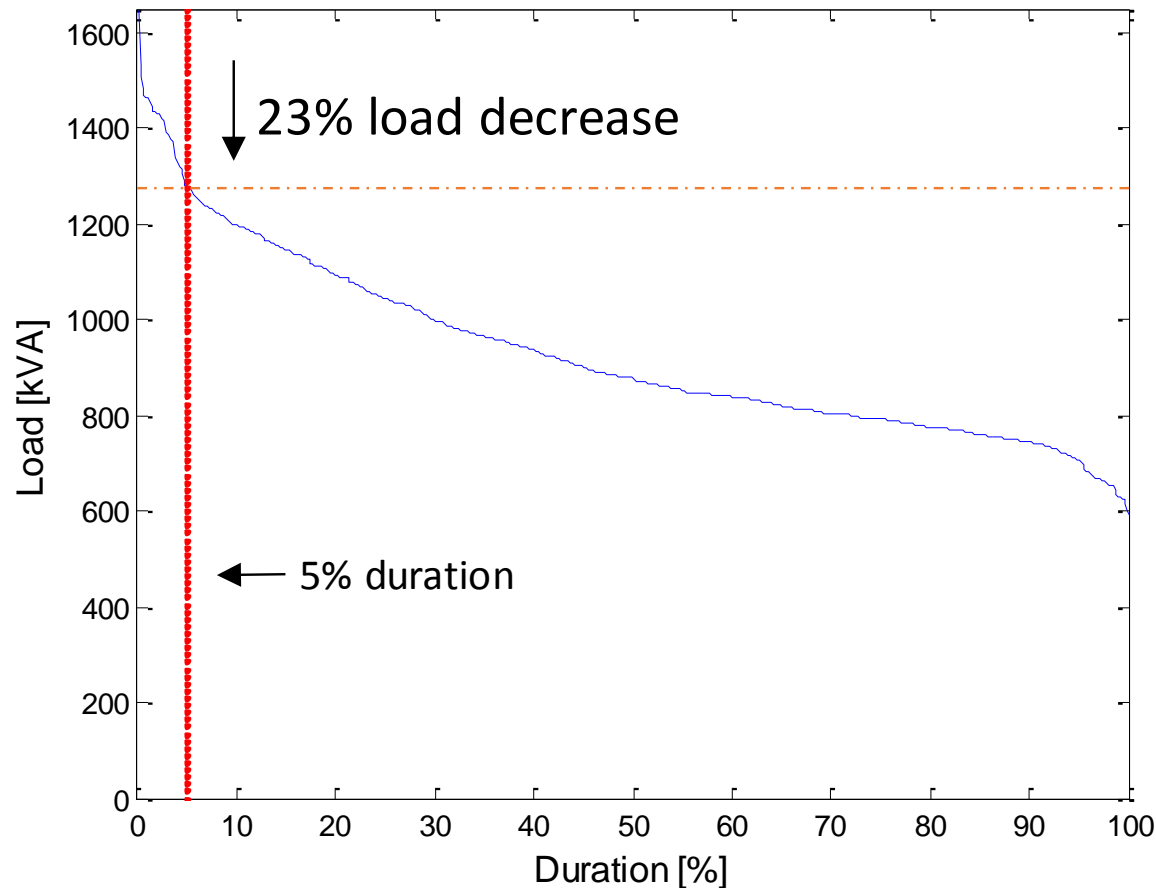

Time (hour) Demand cost (HKD)

0.4% (3 h) 19,969 (10.1%)

1.4% (10h) 24,902 (12.5%)

2.8% (20h) 31,037 (15.6%)

4.2% (30h) 39,579 (19.9%)

Examples of actual electricity charges - Phase 7 in PolyU campus (June/2009)

Load duration, Jun 2009

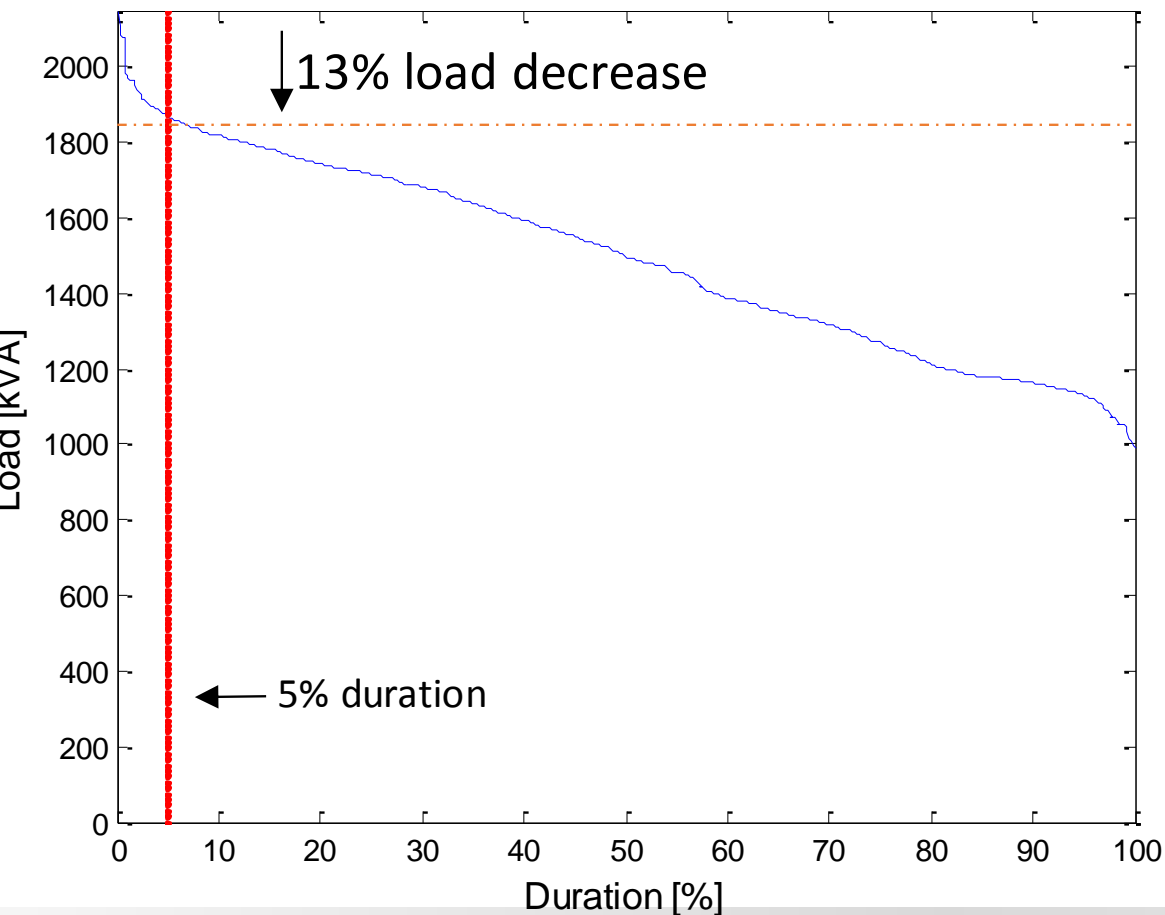

Time (hour) Demand cost(HKD)

0.8% (5h) 19,729 (7.6%)

1.4% (10h) 22,375 (8.6%)

2.8% (20h) 29,232 (11.3%)

4.2% (30h) 32,240 (12.5%)

Summary

- A set of building energy efficient optimal control methods have been developed, and implemented in many real buildings over the past 10 years.
- Beside thermal comfort spaces, optimization methods are also provided for special environments (e.g. cleanrooms).
- According to the analysis on operation data, demand limiting control is attractive for saving electricity cost.

